



**■ Features**

- Universal AC input / Full range
- Built-in active PFC function
- High efficiency up to 91%
- Protections: Short circuit / Over current / Over voltage / Over temperature
- Class II power unit, no FG
- Fanless design, cooling by free air convection
- No load power consumption <0.15W
- Energy efficiency Level VI
- Comply with EISA 2007 DoE and NRCAN
- UL LISTED, suitable for dry and damp locations
- 5 years warranty

**■ Applications**

- LED lighting fixture
- LED decorative lighting
- LED office lighting
- General electronic products in dry or damp environment

**■ Description**

OWA-90U is one 90W single-output external LED power supply series. Pairing the North American type of AC plug and the prevailing DC connectors, OWA-90U, working like an adaptor, simplifies the connection with LED lighting fixtures without extra wiring efforts. The entire series is certified with the “UL LISTED” for dry and damp locations.

As a class II (without earth pin) design, the enclosure of OWA-90U is a 94V-0 flame retardant plastic case. The interior is fully potted with silicone that enhances the heat dissipation. With the working efficiency up to 91%, OWA-90U is cooled by free air convection; the working temperature ranges from -40°C to +70°C.

**■ Model Encoding**

OWA - 90U - 12 -   

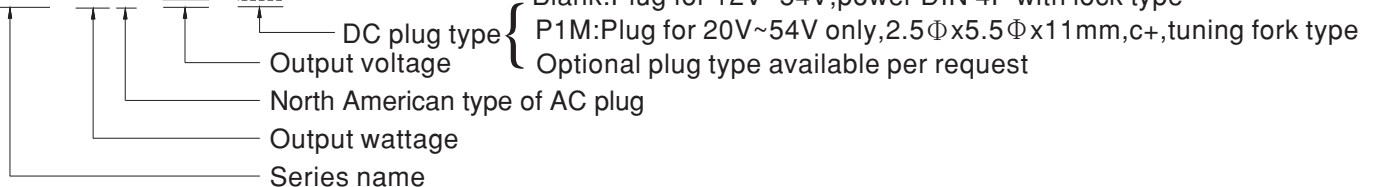



**SPECIFICATION**

MODEL		OWA-90U-12	OWA-90U-15	OWA-90U-20	OWA-90U-24	OWA-90U-30	OWA-90U-36	OWA-90U-42	OWA-90U-48	OWA-90U-54	
OUTPUT	DC VOLTAGE	12V	15V	20V	24V	30V	36V	42V	48V	54V	
	CONSTANT CURRENT REGION	7.2 ~ 12V	9 ~ 15V	12 ~ 20V	14.4 ~ 24V	18 ~ 30V	21.6 ~ 36V	25.2 ~ 42V	28.8 ~ 48V	32.4 ~ 54V	
	RATED CURRENT	7.5A	6A	4.5A	3.75A	3A	2.5A	2.15A	1.88A	1.67A	
	RATED POWER	90W	90W	90W	90W	90W	90W	90.3W	90.24W	90.18W	
	RIPPLE & NOISE (max.) Note.2	150mVp-p	150mVp-p	150mVp-p	150mVp-p	200mVp-p	200mVp-p	250mVp-p	250mVp-p	350mVp-p	
	VOLTAGE TOLERANCE Note.3	±4.0%	±4.0%	±4.0%	±3.0%	±3.0%	±2.0%	±1.0%	±1.0%	±1.0%	
	LINE REGULATION	±0.5%	±0.5%	±0.5%	±0.5%	±0.5%	±0.5%	±0.5%	±0.5%	±0.5%	
	LOAD REGULATION	±1.5%	±1.0%	±0.5%	±0.5%	±0.5%	±0.5%	±0.5%	±0.5%	±0.5%	
	SETUP, RISE TIME Note.4	500ms, 80ms at 95% load 115VAC / 230VAC									
	HOLD UP TIME (Typ.)	16ms at full load 115VAC / 230VAC									
INPUT	VOLTAGE RANGE	90 ~ 264VAC 127 ~ 370VDC									
	FREQUENCY RANGE	47 ~ 63Hz									
	POWER FACTOR (Typ.)	PF>0.98/115VAC, PF>0.96/230VAC at full load									
	TOTAL HARMONIC DISTORTION	THD< 20% when output loading ≥60% at 115VAC/230VAC									
	EFFICIENCY (Typ.)	115VAC	88%	89%	89%	89%	89%	89.5%	89.5%	89.5%	89.5%
		230VAC	89%	90%	90%	90%	90%	91%	91%	91%	91%
	AC CURRENT (Typ.)	0.95A / 115VAC 0.5A / 230VAC									
	INRUSH CURRENT (Typ.)	COLD START 30A (twidh=550μs measured at 50% Ipeak) at 115VAC COLD START 60A (twidh=550μs measured at 50% Ipeak) at 230VAC									
MAX. NO. of PSUs on 16A CIRCUIT BREAKER	3 units (circuit breaker of type B) / 6 units (circuit breaker of type C) at 230VAC										
LEAKAGE CURRENT	<0.125mA / 120VAC <0.25mA / 240VAC										
PROTECTION	OVER CURRENT	95 ~ 108% Protection type : Constant current limiting, recovers automatically after fault condition is removed									
	SHORT CIRCUIT	Hiccup mode, recovers automatically after fault condition is removed									
	OVER VOLTAGE	15 ~ 17V   17.5 ~ 21V   23 ~ 27V   28 ~ 34V   34 ~ 40V   41 ~ 46V   46 ~ 54V   54 ~ 60V   59 ~ 66V									
		Protection type : Shut down o/p voltage, re-power on to recover									
	OVER TEMPERATURE	Shut down o/p voltage, re-power on to recover									
ENVIRONMENT	WORKING TEMP.	-40 ~ +70°C (Refer to "Derating Curve")									
	WORKING HUMIDITY	20 ~ 95% RH non-condensing									
	STORAGE TEMP., HUMIDITY	-40 ~ +80°C, 10 ~ 95% RH									
	TEMP. COEFFICIENT	±0.03%/°C (0 ~ 50°C)									
	VIBRATION	10 ~ 500Hz, 5G 12min./1cycle, period for 72min. each along X, Y, Z axes									
SAFETY & EMC	SAFETY STANDARDS	UI8750 listed, CSA C22.2 No. 250.13-12(except for 42V, 48V, 54V); IP67(for main body ) approved									
	WITHSTAND VOLTAGE	I/P-O/P:3.75KVAC									
	ISOLATION RESISTANCE	I/P-O/P:100M Ohms / 500VDC / 25°C / 70% RH									
	EMC EMISSION	Compliance to FCC Part15									
OTHERS	MTBF	292.8K hrs min. MIL-HDBK-217F (25°C)									
	DIMENSION	171*63*37.5mm									
	PACKING	0.83Kg; 16pcs/14.3Kg/1.01CUFT									
NOTE	<p>1. All parameters NOT specially mentioned are measured at 230VAC input, rated load and 25°C of ambient temperature.</p> <p>2. Ripple &amp; noise are measured at 20MHz of bandwidth by using a 12" twisted pair-wire terminated with a 0.1uf &amp; 47uf parallel capacitor.</p> <p>3. Tolerance : includes set up tolerance, line regulation and load regulation.</p> <p>4. Length of set up time is measured at cold first start. Turning ON/OFF the power supply may lead to increase of the set up time.</p>										

■ Block Diagram

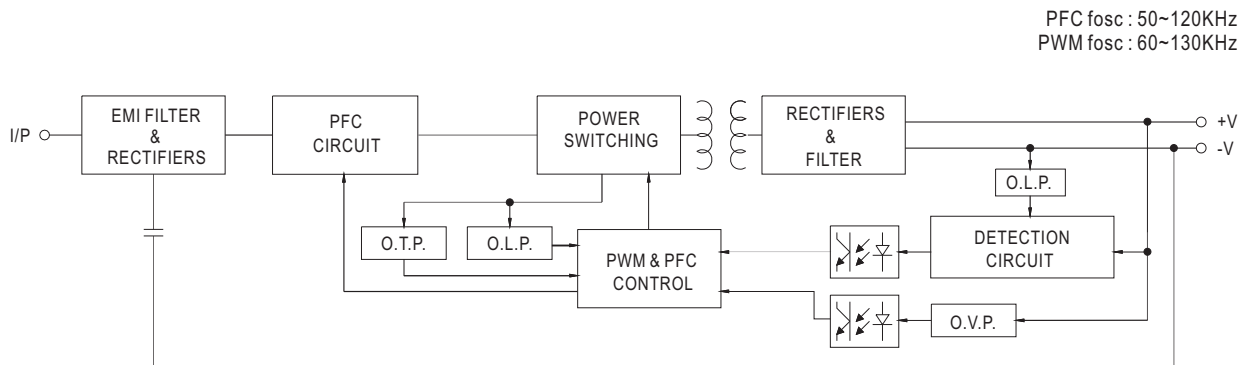

■ Derating Curve

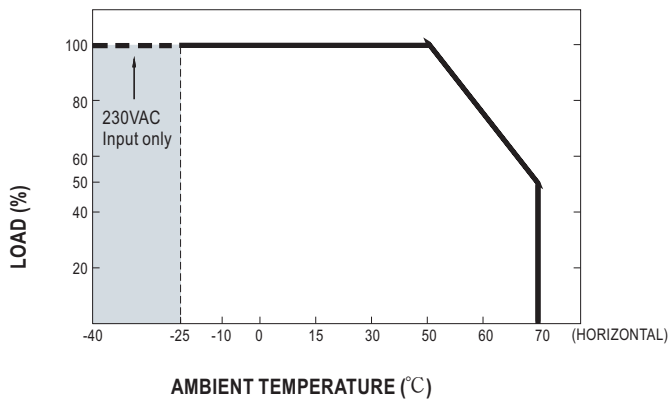

■ Static Characteristics

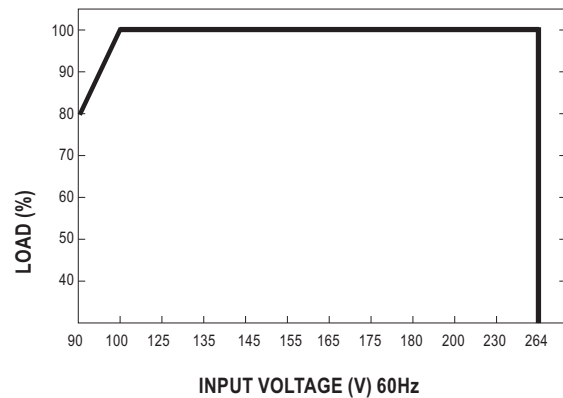

■ Power Factor Characteristic

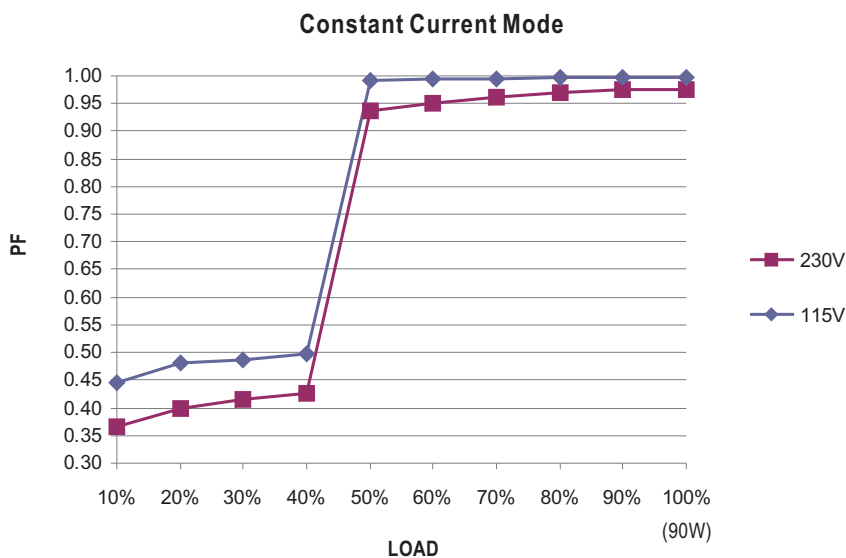

**EFFICIENCY vs LOAD (48V Model)**

OWA-90U series possess superior working efficiency that up to 91% can be reached in field applications.

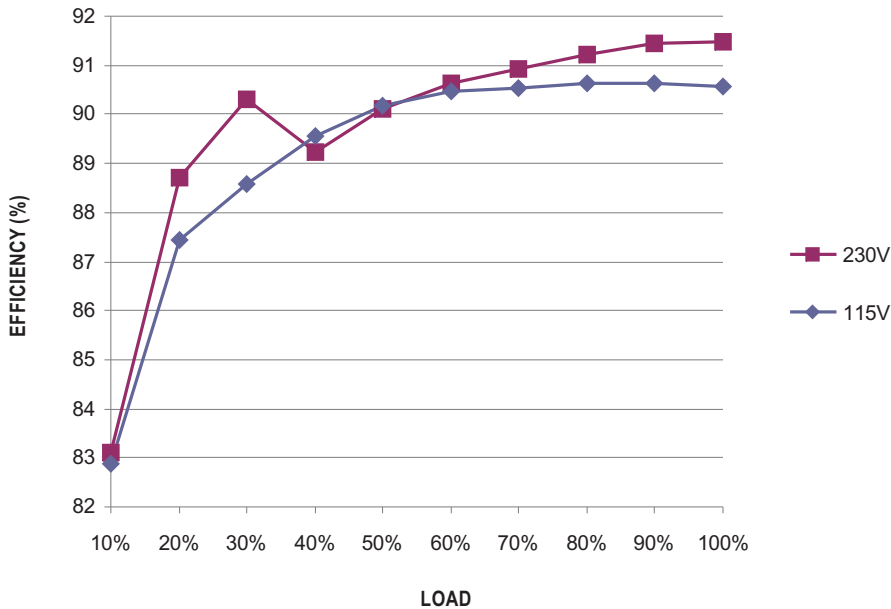

**DRIVING METHODS OF LED MODULE**

There are two major kinds of LED drive method, "direct drive" and "with LED driver".

A typical LED power supply may either work in "constant voltage mode (CV)" or "constant current mode (CC)" to drive the LEDs.

Mean Well's LED power supply with CV+ CC characteristic can be operated at both CV mode (with LED driver, at area (A) and CC mode (direct drive, at area (B)).

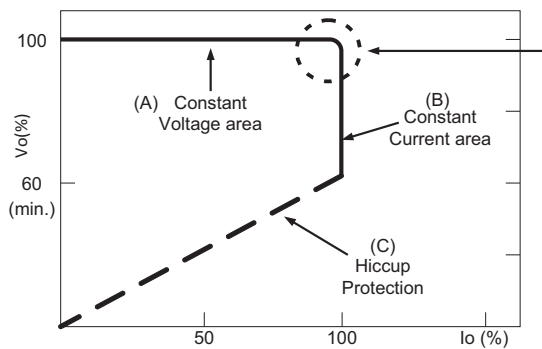

Typical LED power supply I-V curve

In the constant current region, the highest voltage at the output of the driver depends on the configuration of the end systems.

Should there be any compatibility issues, please contact MEAN WELL.

### Mechanical Specification

Unit:mm

Blank Type:(OWA-90U-\_)

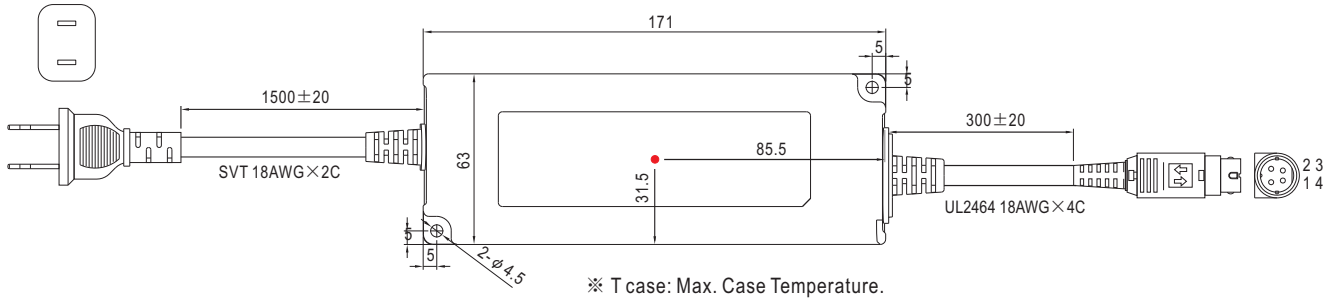

P1M Type:(OWA-90U-\_-P1M)

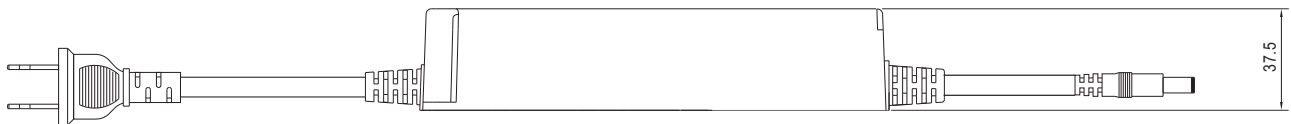
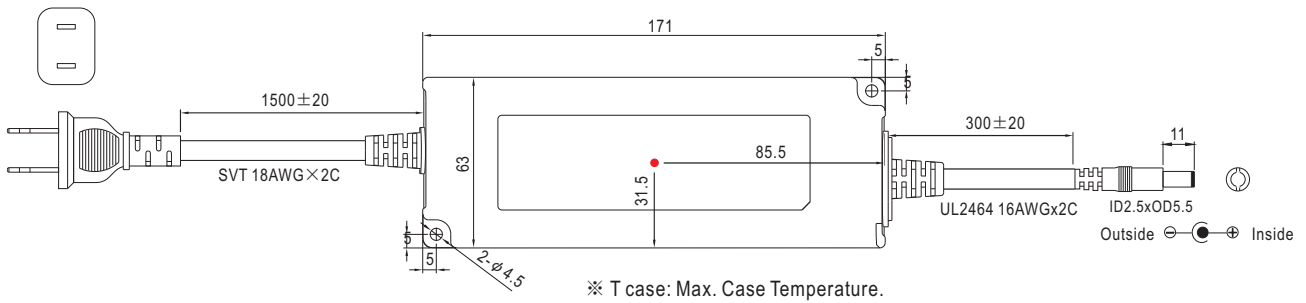

### Input Plug Type

All models : NEMA 1-15p male plug

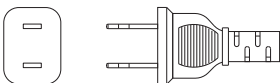

### Output Plug Assignment

Plug for all standard models(12V~54V) :  
power DIN 4 pins with lock type,  
KYCON KPPX-4P, or equivalent

PIN NO.	OUTPUT
1,4	+V
2,3	-V

Plug for 20V~54V only :

PIN NO.	OUTPUT
CENTER	+V



■ **Recommend Mounting Direction**

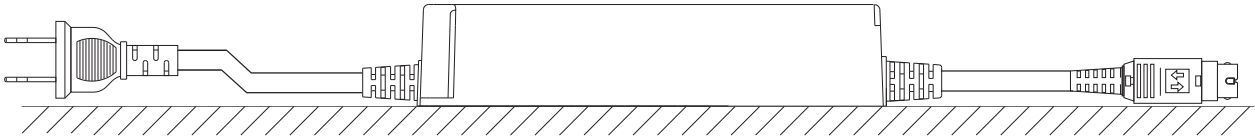

■ **Installation Manual**

Please refer to : <http://www.meanwell.com/search/OWA-90U/OWA-U-E.pdf>